

L'INVISIBLE SPECIAL CLOSURES
technical data



Technical specifications

L'INVISIBLE SPECIAL CLOSURES, a patented system for flush to wall doors and panels (aluminium frame and hidden hinges).

Frame Nucleo in tubular, extruded aluminium alloy "6060 T5 ANTICORODAL 063" planned for Pull (MOD. T) opening. Adaptable to all wall depths for traditional walls, plasterboard or other material. Prepared for paint coating, enamels, etc.

It can be made in any shape or size. Assembly of the frame Nucleo with aluminium hidden brackets and MDF 19 mm, type BH, panel finished in 7010 white colour (ready to varnish).

Salice hinges (neck 9 diametre 35) without steel, nickled ring, for 90° and 180° door opening. Salice hinges (neck 24 diametre 40) for maximum 10 mm depth finish, for 90° door opening.

Types of openings

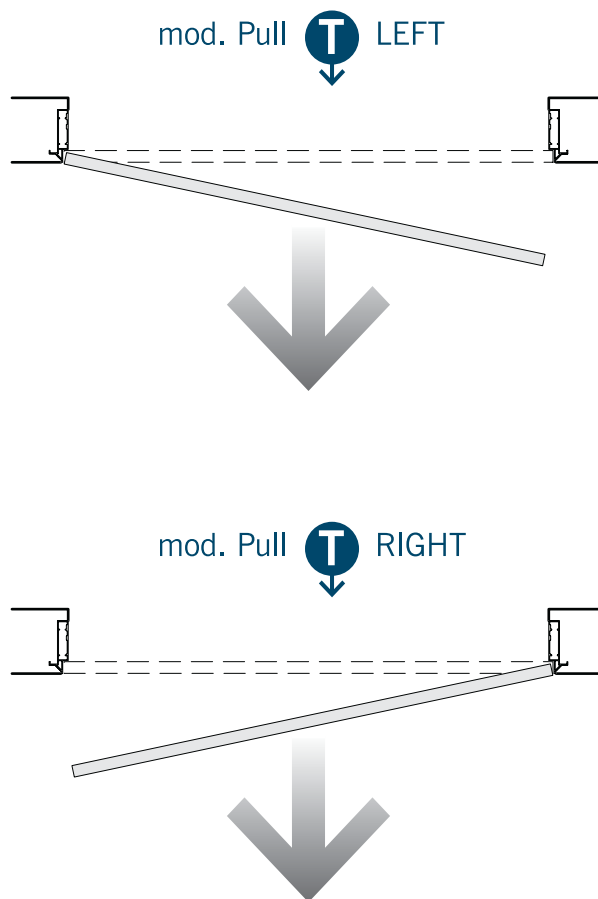

section post / rail

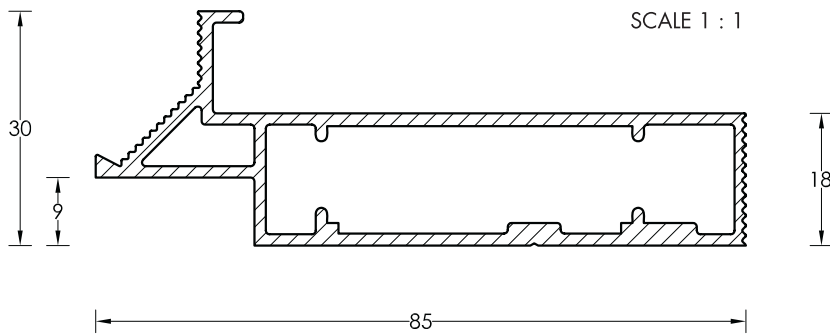

for masonry walls in all depths

example: LEFT PULL

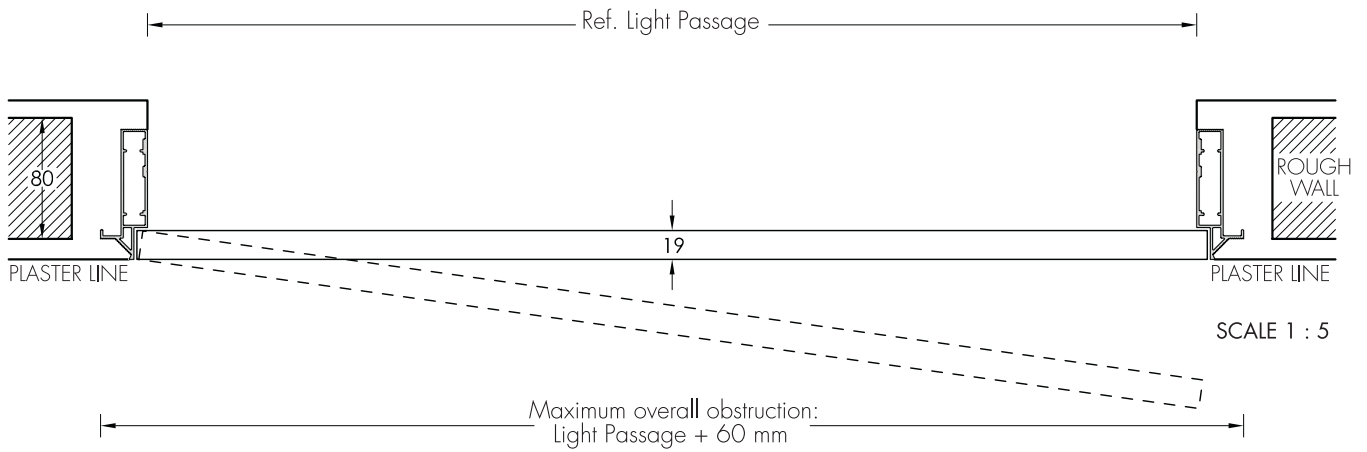

for plasterboard walls

example: RIGHT PULL

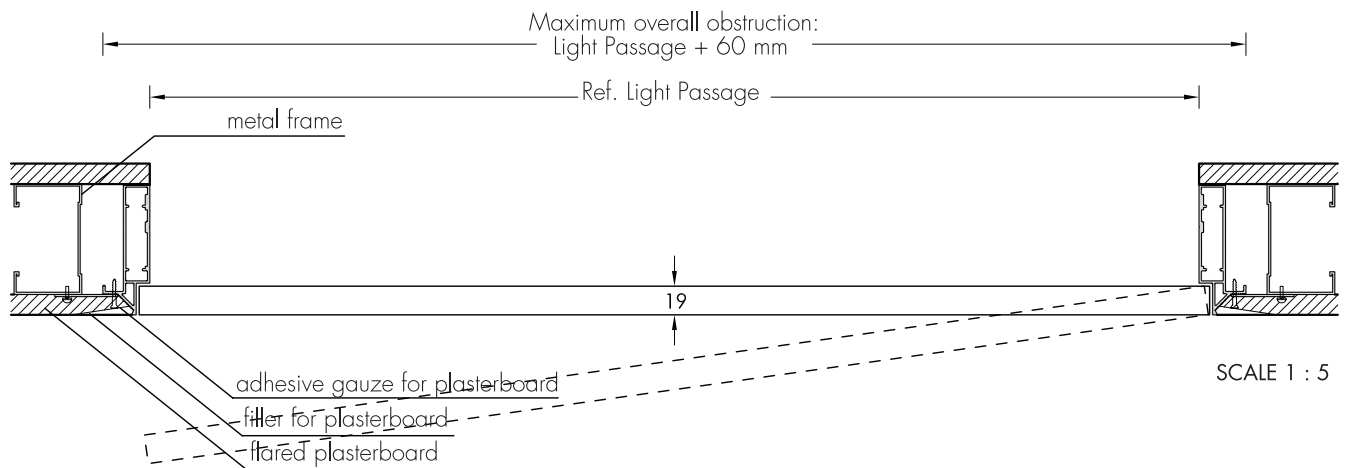

rough wall opening | calculation of measurements

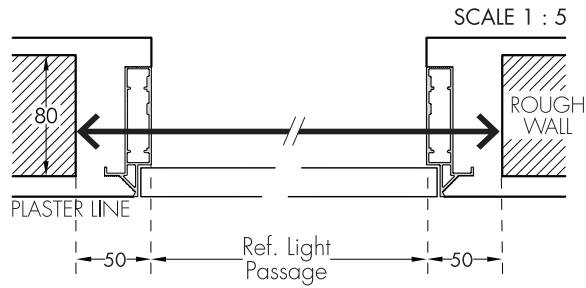

4 sides frame

ROUGH WALL OPENING CALCULATION	
<i>width</i>	light passage + 100 mm
<i>height</i>	light passage + 100 mm

3 sides frame

ROUGH WALL OPENING CALCULATION	
<i>width</i>	light passage + 100 mm
<i>height</i>	light passage + 50 mm

usable space for plasterboard opening | calculation of measurements

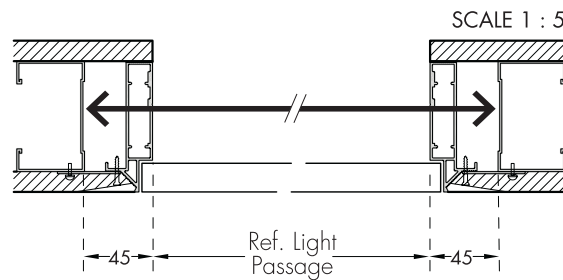
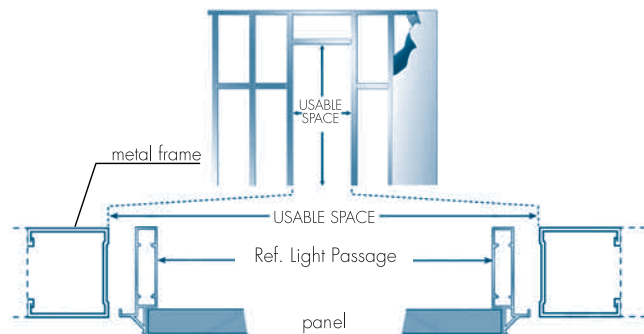

4 sides frame

USABLE SPACE CALCULATION	
<i>width</i>	light passage + 90 mm
<i>height</i>	light passage + 90 mm
example: door (light passage): 800x2100 mm usable space: 890x2190 mm	

3 sides frame

USABLE SPACE CALCULATION	
<i>width</i>	light passage + 90 mm
<i>height</i>	light passage + 45 mm
example: door (light passage): 800x2100 mm usable space: 890x2145 mm	

material supplied in kit

4/8 PLATES 40 x 15 mm
(for mounting on plasterboard)

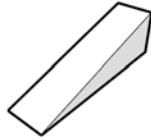

4/6 WOODEN WEDGES

necessary materials on site (not supplied)

LEVEL



2 ALUMINIUM RULES
50 x 50 x 1400 mm

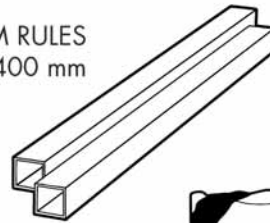

4 MASONRY SPRINGS



4 CLAMPS

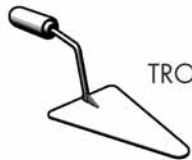

TROWEL

4 RULE-STOPS



PLUMBLINE



QUICK-SETTING CEMENT

